

単位 : mm

200

150

100

50

0

瞬間最大反力

MN (ton·f)

FR	0.07 (7)
FL	0.07 (7)
RR	0.06 (6)
RL	0.06 (6)

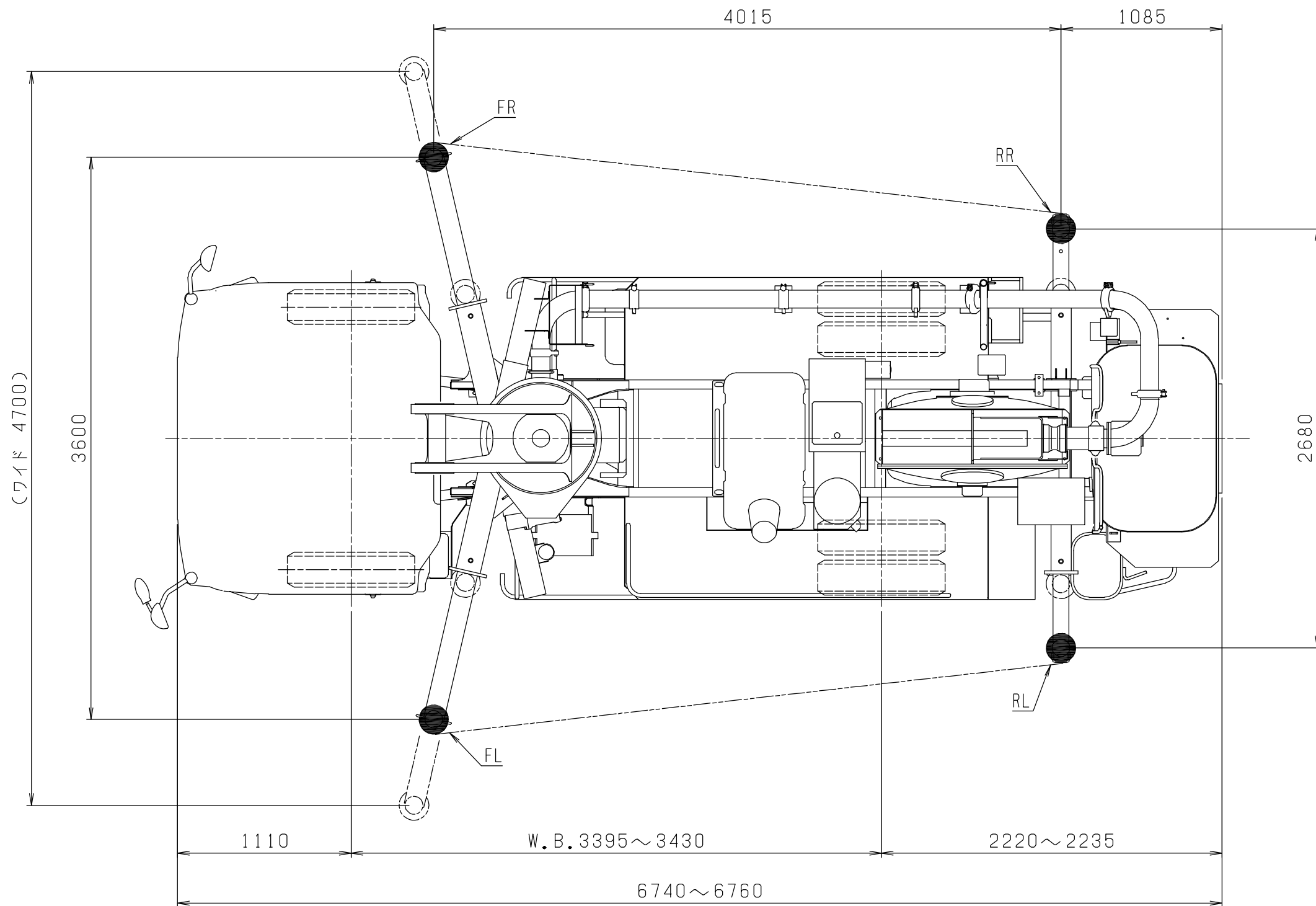

PH50C-17

アウトリガ反力

Kyokuto Kaihatsu Kogyo Co., Ltd.